

HW for Real Life Similarity

HEIGHT How tall is Becky?

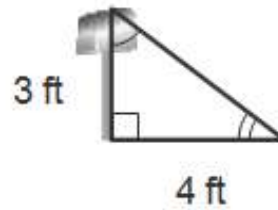

FLAGS How tall is the flagpole?

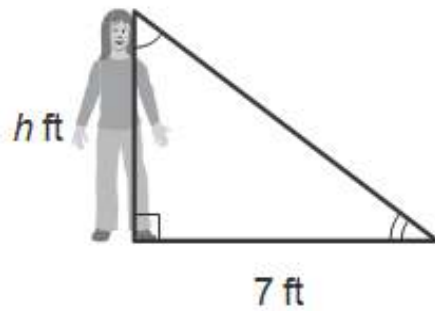
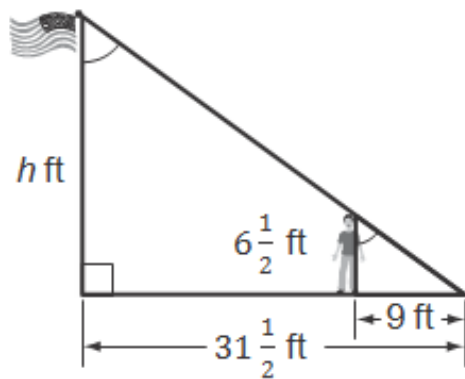

HW for Real Life Similarity

ACCESSIBILITY How high is the ramp when it is 2 feet from the building?
(Hint: $\triangle ABE \sim \triangle ACD$)

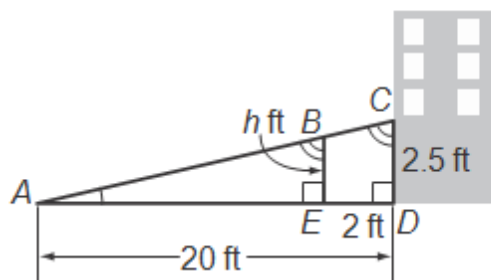

BEACH How deep is the water 50 feet from shore?

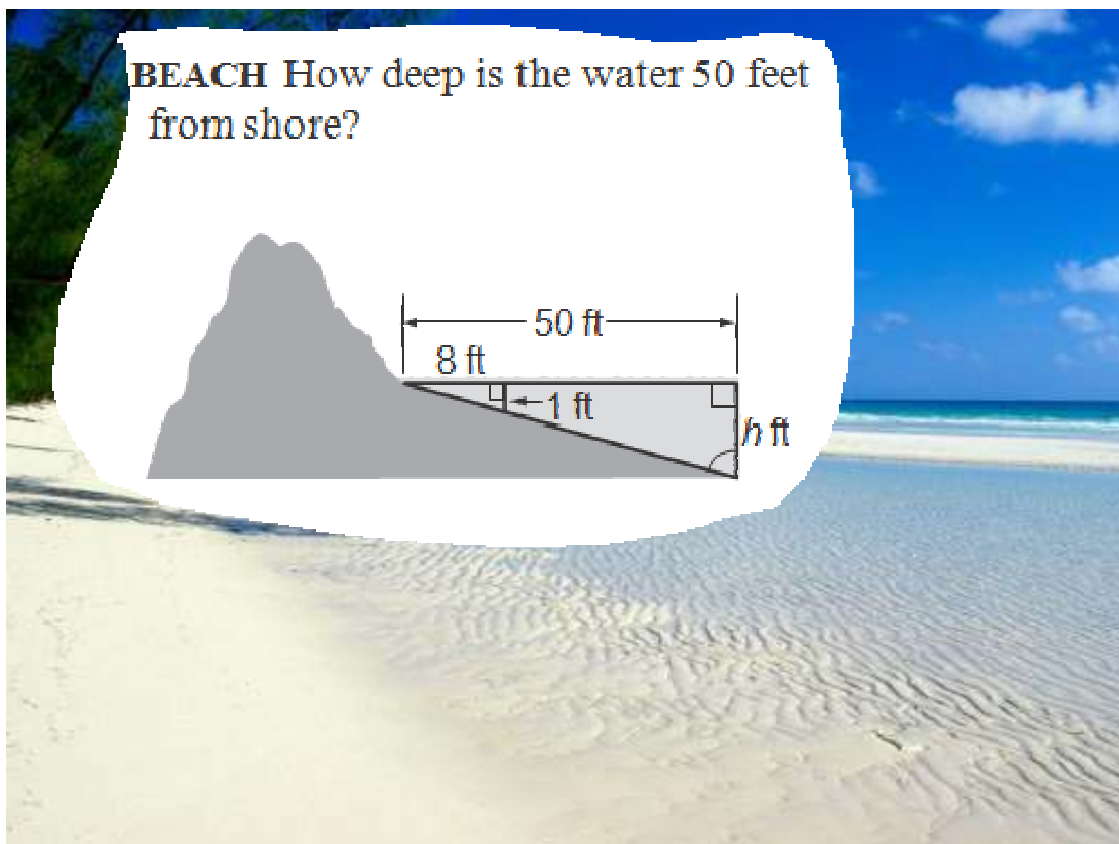

HW for Real Life Similarity

AMUSEMENT PARKS How far is the water ride from the roller coaster? Round to the nearest tenth.

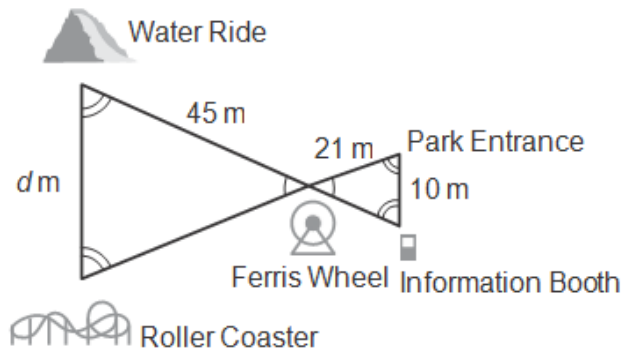

CLASS CHANGES How far is the entrance to the gymnasium from the band room?

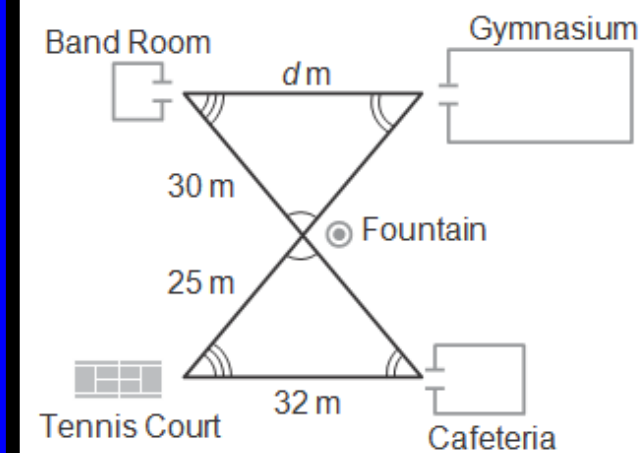

HW for Real Life Similarity

LIGHTING Tyrone is standing next to a light pole in the middle of the day. Tyrone's shadow is 1.5 feet long, and the light pole's shadow is 4.5 feet long. If Tyrone is 6 feet tall, how tall is the light pole?

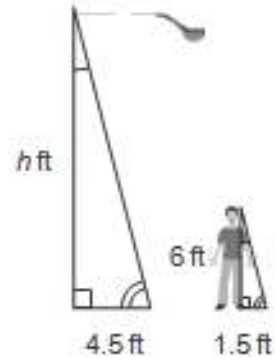

MONUMENTS A statue casts a shadow 30 feet long. At the same time, a person who is 5 feet tall casts a shadow that is 6 feet long. How tall is the statue?

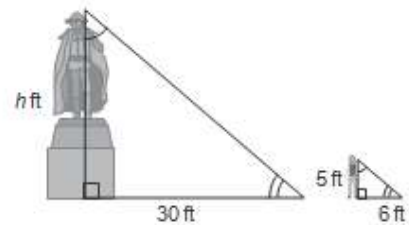

HW for Real Life Similarity